

CAN SWITCH BOARD

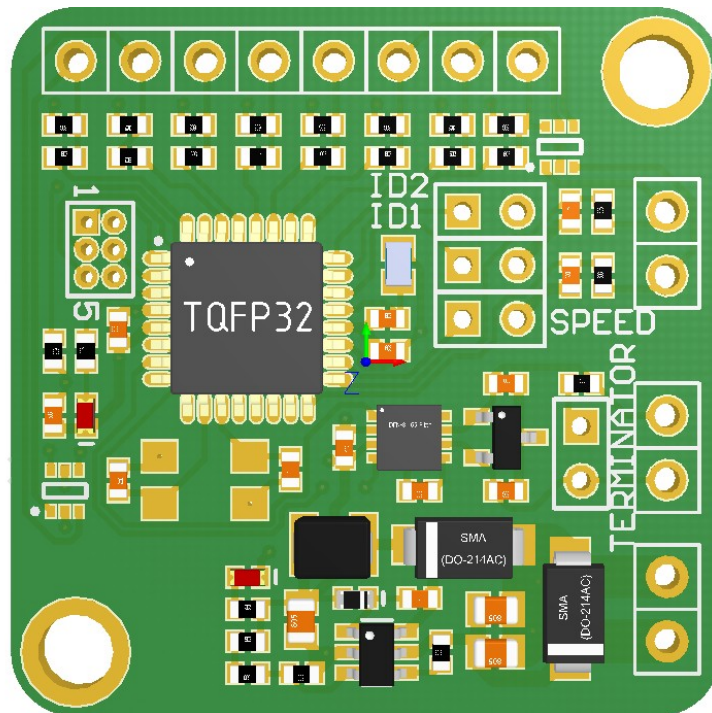

PRODUCT INFORMATION

CAN switch board is a device that send information about state of 8 switches (switched to ground) and two analog volatages (in format of mV) over CAN BUS.

THIS PRODUCT IS INTENDED FOR CLOSED-COURSE RACING ONLY

CONNECTION

The board requires +12V power (after ignition switch). The +5V could be used for powering pots. All switches are active when switched to ground.

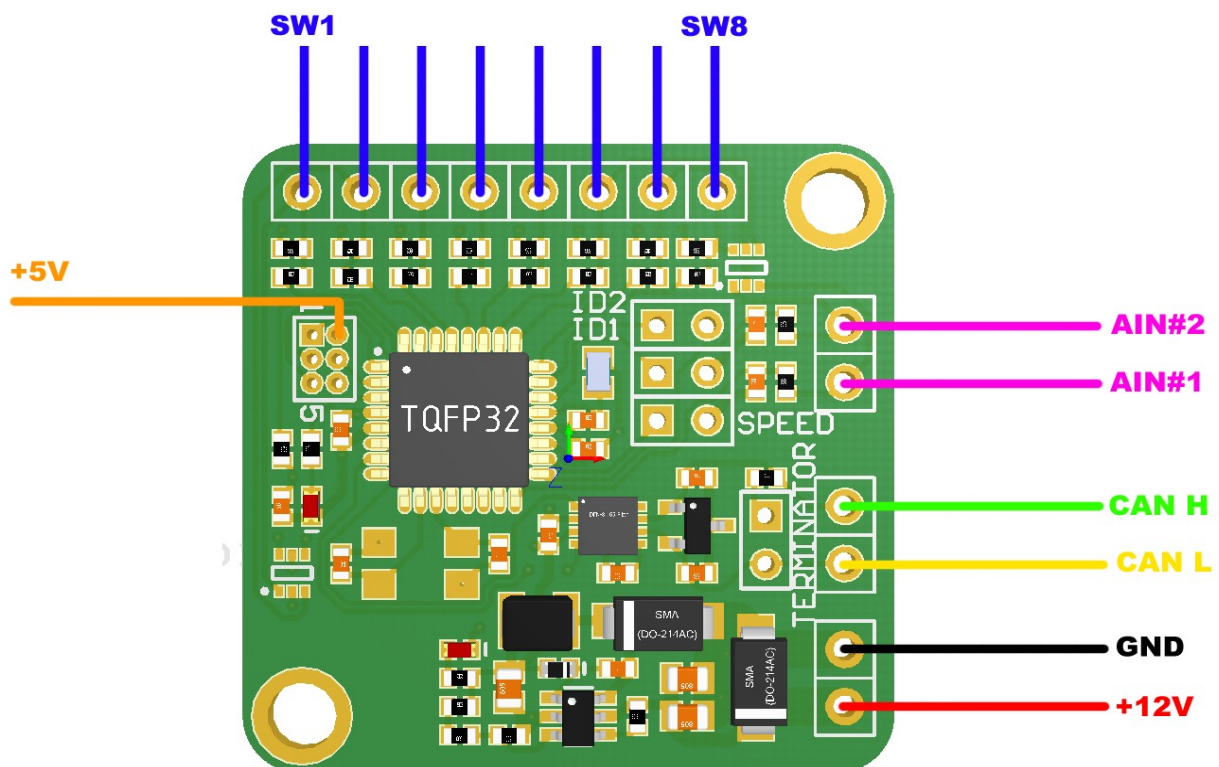

CAN BUS

The device supports CAN 2.0A/B and the speed 500Kbps and 1Mbps. By default the communication speed is 500Kbps. For 1Mbps the jumper SPEED should be shorted.

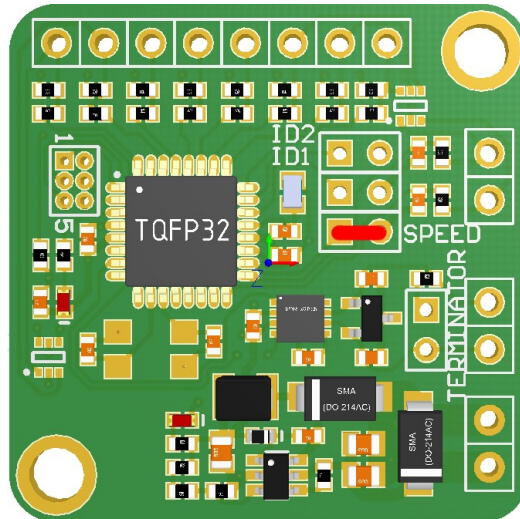

If there is a need of CAN termination (120 Ohm), TERMINATION jumper could be short.

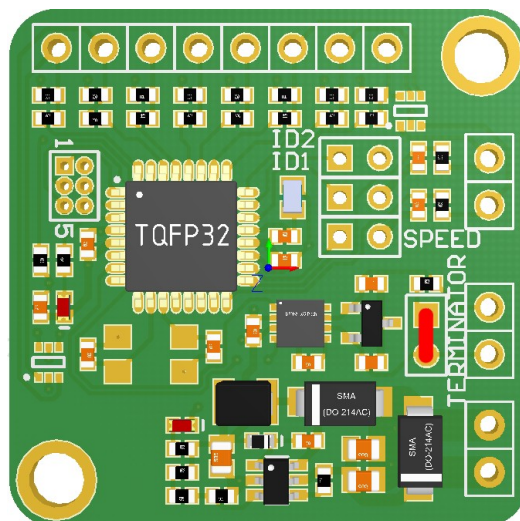

CAN DATA FORMAT

CAN switch board supports 4 different frame format selected by ID1 and ID2 switch
Messages frequency is 20Hz, pots values in mV are in big endian format (0-5000).

FORMAT 0 (no jumpers)

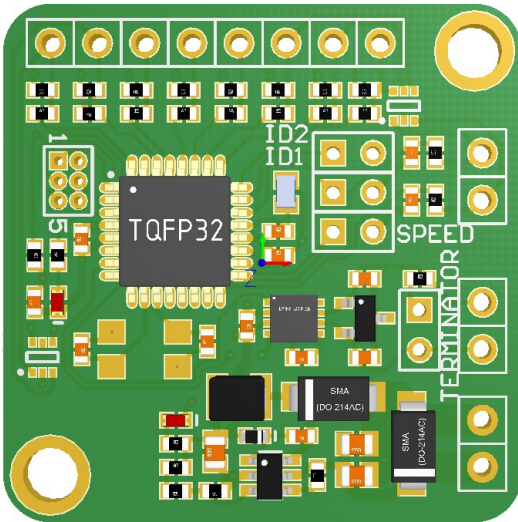

ID	DLC	Byte 0	Byte 1	Byte 2	Byte 3	Byte 4	Byte 5	Byte 6	Byte 7
0x334	8	Analog#1(mV)		Analog#2 (mV)		CALPOT 1	CAL POT 2	Switch mask	Heartbeat
ID	DLC	Byte 0	Byte 1	Byte 2	Byte 3	Byte 4	Byte 5	Byte 6	Byte 7
0x335	8	CALPOT 1	SW#1	SW#2	SW#3	SW#4	SW#5	SW#6	SW#7
ID	DLC	Byte 0	Byte 1	Byte 2	Byte 3	Byte 4	Byte 5	Byte 6	Byte 7
0x336	8	CALPOT 2	SW#8						

Parameter	Description
Analog#1	Voltage value from analog #1 input 0-5000mV, big endian
Analog#2	Voltage value from analog #2 input 0-5000mV, big endian
Switch mask	bit mask of pressed switches (1 means pressed)
CAL POT #1	The discrete value of analog #1 input. The voltage for each value is multiplication of 384mV
CAL POT #2	The discrete value of analog #2 input. The voltage for each value is multiplication of 384mV
Heartbeat	Counter incremented every sent message

FORMAT 1 (ID1 jumper)

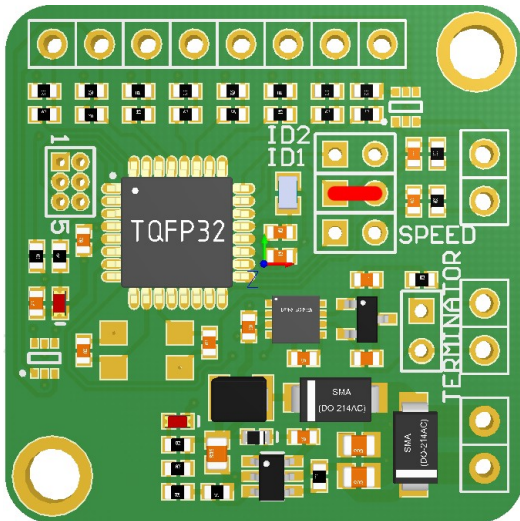

ID	DLC	Byte 0	Byte 1	Byte 2	Byte 3	Byte 4	Byte 5	Byte 6	Byte 7
0x334	8	Analog#1(mV)		Analog#2 (mV)		CALPOT 1	CAL POT 2	Switch mask	Heartbeat

Parameter	Description
Analog#1	Voltage value from analog #1 input 0-5000mV, big endian
Analog#2	Voltage value from analog #2 input 0-5000mV, big endian
Switch mask	bit mask of pressed switches (1 means pressed)
CAL POT #1	The discrete value of analog #1 input. The voltage for each value is multiplication of 384mV
CAL POT #2	The discrete value of analog #2 input. The voltage for each value is multiplication of 384mV
Heartbeat	Counter incremented every sent message

FORMAT 2 (ID2 jumper)

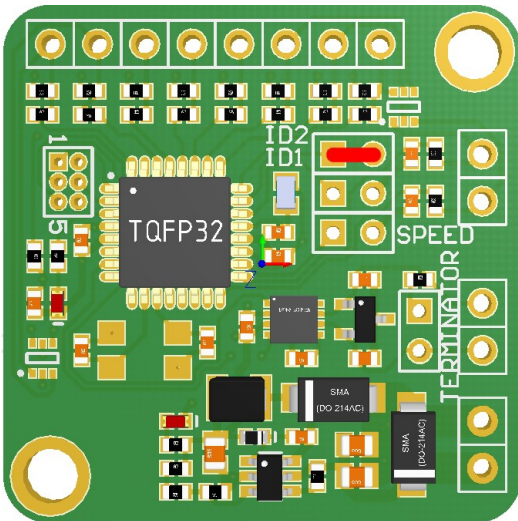

ID	DLC	Byte 0	Byte 1	Byte 2	Byte 3	Byte 4	Byte 5	Byte 6	Byte 7
0x666	8	Analog#1(mV)		Analog#2 (mV)		CALPOT 1	CAL POT 2	Switch mask	Heartbeat

Parameter	Description
Analog#1	Voltage value from analog #1 input 0-5000mV, big endian
Analog#2	Voltage value from analog #2 input 0-5000mV, big endian
Switch mask	bit mask of pressed switches (1 means pressed)
CAL POT #1	The discrete value of analog #1 input. The voltage for each value is multiplication of 384mV
CAL POT #2	The discrete value of analog #2 input. The voltage for each value is multiplication of 384mV
Heartbeat	Counter incremented every sent message

FORMAT 3 (ID1 and ID2 jumper)

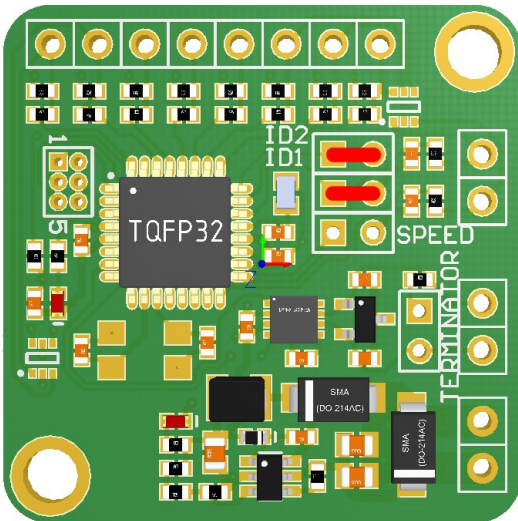

ID	DLC	Byte 0	Byte 1	Byte 2	Byte 3	Byte 4	Byte 5	Byte 6	Byte 7
0xA1BA2f1	8	Analog#1(mV)	Analog#2 (mV)	CALPOT 1	CAL POT 2	Switch mask	Heartbeat		

Parameter	Description
Analog#1	Voltage value from analog #1 input 0-5000mV, big endian
Analog#2	Voltage value from analog #2 input 0-5000mV, big endian
Switch mask	bit mask of pressed switches (1 means pressed)
CAL POT #1	The discrete value of analog #1 input. The voltage for each value is multiplication of 384mV
CAL POT #2	The discrete value of analog #2 input. The voltage for each value is multiplication of 384mV
Heartbeat	Counter incremented every sent message