

CAN SWITCH BOARD

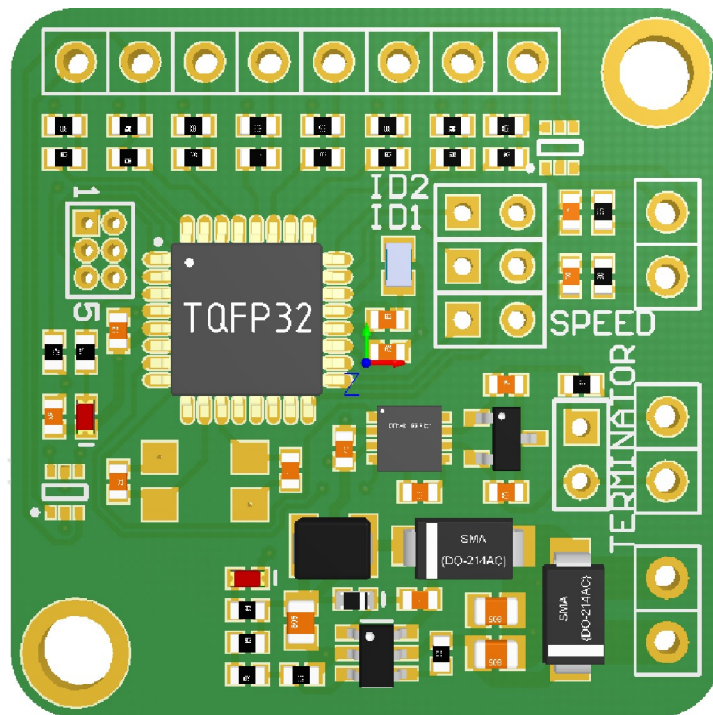

PRODUCT INFORMATION

CAN switch board is a device that send information about state of 8 switches (switched to ground) and two analog volatages (in format of mV) over CAN BUS.

THIS PRODUCT IS INTENDED FOR CLOSED-COURSE RACING ONLY

CONNECTION

The board requires +12V power (after ignition switch). The +5V could be used for powering pots. All switches are active when switched to ground.

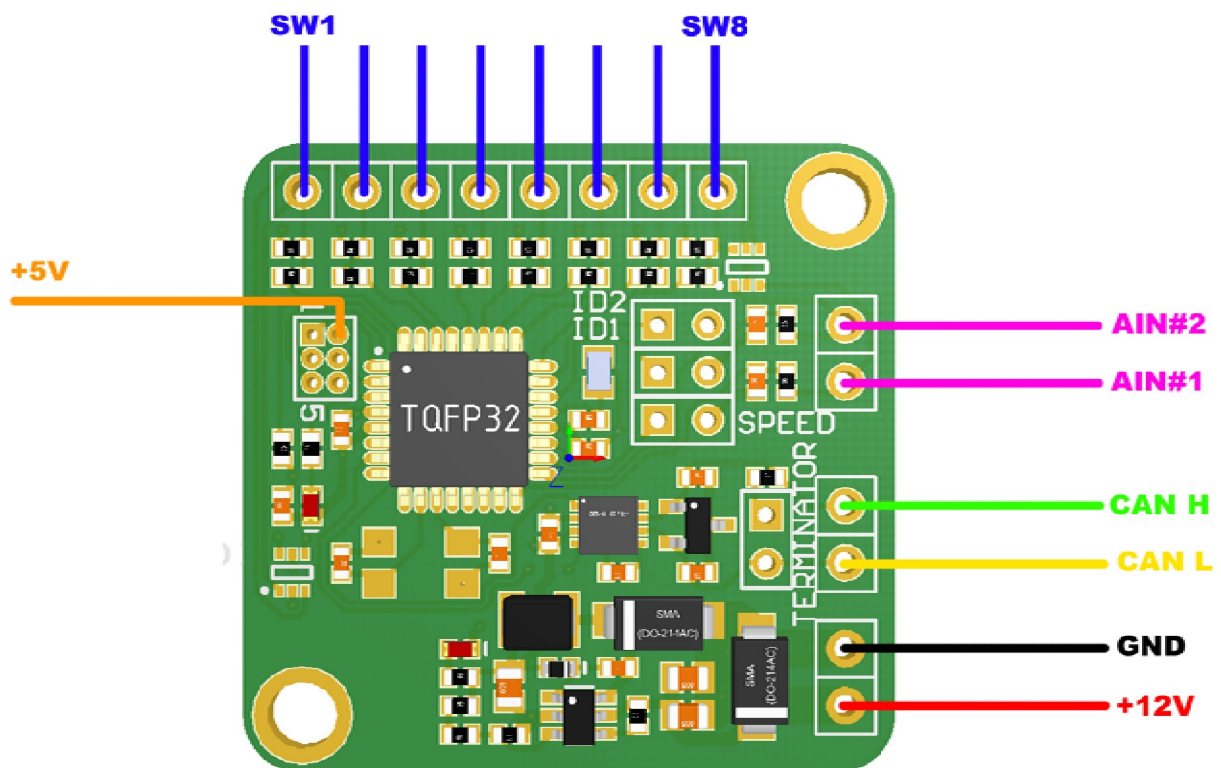

CAN BUS

The device supports CAN 2.0A/B and the speed 500Kbps and 1Mbps. By default the communication speed is 500Kbps. For 1Mbps the jumper SPEED should be shorted.

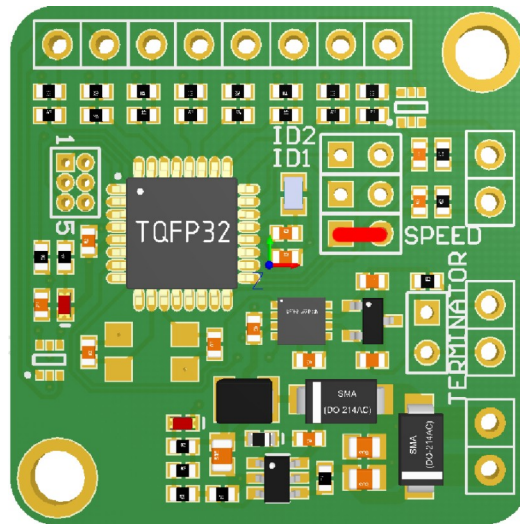

If there is a need of CAN termination (120 Ohm), TERMINATION jumper could be short.

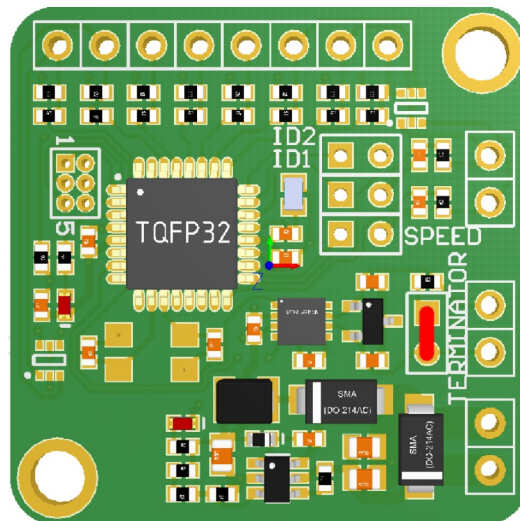

CAN DATA FORMAT

CAN switch board supports 4 different frame format selected by ID1 and ID2 switch
Messages frequency is 20Hz, pots values in mV are in big endian format (0-5000).

FORMAT 0 (no jumpers)

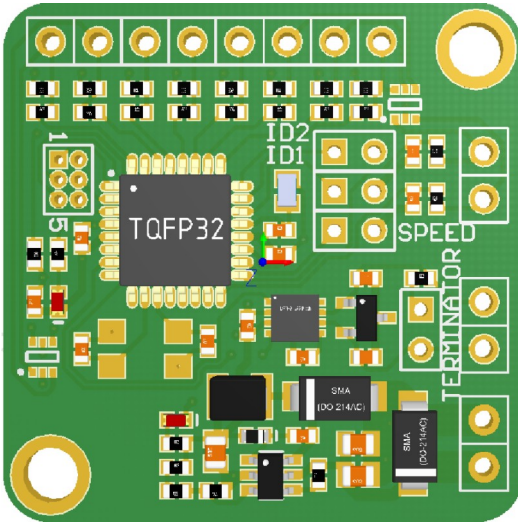

ID	DLC	Byte 0	Byte 1	Byte 2	Byte 3	Byte 4	Byte 5	Byte 6	Byte 7
0x334	8	Analog#1(mV)		Analog#2 (mV)		CALPOT 1	CAL POT 2	Switch mask	Heartbeat
ID	DLC	Byte 0	Byte 1	Byte 2	Byte 3	Byte 4	Byte 5	Byte 6	Byte 7
0x335	8	CALPOT 1	SW#1	SW#2	SW#3	SW#4	SW#5	SW#6	SW#7
ID	DLC	Byte 0	Byte 1	Byte 2	Byte 3	Byte 4	Byte 5	Byte 6	Byte 7
0x336	8	CALPOT 2	SW#8						

Parameter	Description
Analog#1	Voltage value from analog #1 input 0-5000mV, big endian
Analog#2	Voltage value from analog #2 input 0-5000mV, big endian
Switch mask	bit mask of pressed switches (1 means pressed)
CAL POT #1	The discrete value of analog #1 input. The voltage for each value is multiplication of 384mV
CAL POT #2	The discrete value of analog #2 input. The voltage for each value is multiplication of 384mV
Heartbeat	Counter incremented every sent message

FORMAT 1 (ID1 jumper)

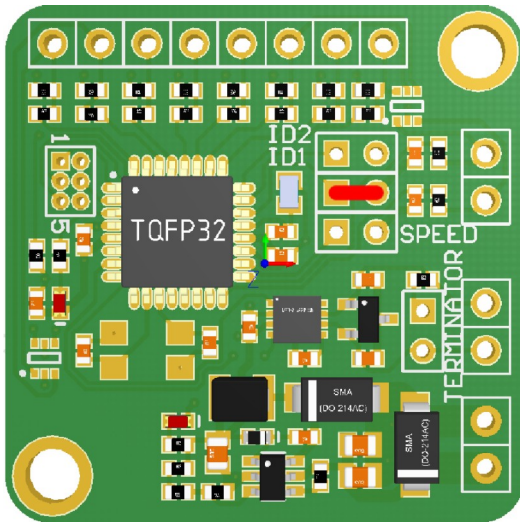

ID	DLC	Byte 0	Byte 1	Byte 2	Byte 3	Byte 4	Byte 5	Byte 6	Byte 7
0x334	8	Analog#1(mV)		Analog#2 (mV)		CALPOT 1	CAL POT 2	Switch mask	Heartbeat

Parameter	Description
Analog#1	Voltage value from analog #1 input 0-5000mV, big endian
Analog#2	Voltage value from analog #2 input 0-5000mV, big endian
Switch mask	bit mask of pressed switches (1 means pressed)
CAL POT #1	The discrete value of analog #1 input. The voltage for each value is multiplication of 384mV
CAL POT #2	The discrete value of analog #2 input. The voltage for each value is multiplication of 384mV
Heartbeat	Counter incremented every sent message

FORMAT 2 (ID2 jumper)

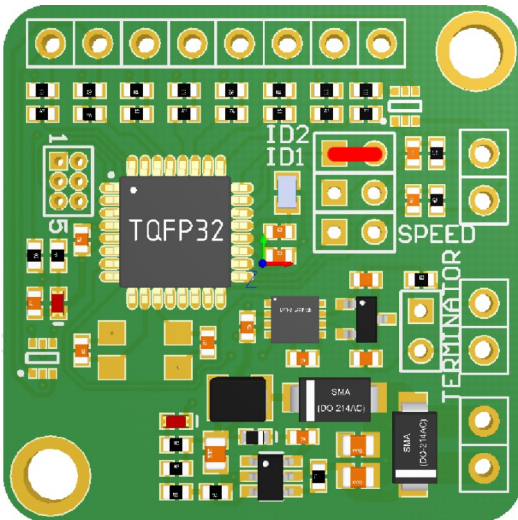

ID	DLC	Byte 0	Byte 1	Byte 2	Byte 3	Byte 4	Byte 5	Byte 6	Byte 7
0x666	8	Analog#1(mV)		Analog#2 (mV)		CALPOT 1	CAL POT 2	Switch mask	Heartbeat

Parameter	Description
Analog#1	Voltage value from analog #1 input 0-5000mV, big endian
Analog#2	Voltage value from analog #2 input 0-5000mV, big endian
Switch mask	bit mask of pressed switches (1 means pressed)
CAL POT #1	The discrete value of analog #1 input. The voltage for each value is multiplication of 384mV
CAL POT #2	The discrete value of analog #2 input. The voltage for each value is multiplication of 384mV
Heartbeat	Counter incremented every sent message

FORMAT 3 (ID1 and ID2 jumper)

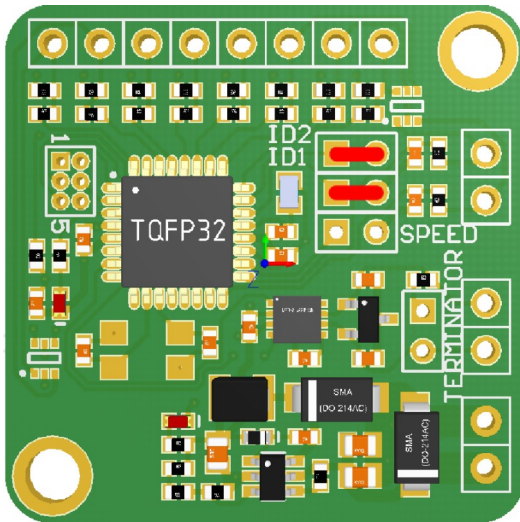

ID	DLC	Byte 0	Byte 1	Byte 2	Byte 3	Byte 4	Byte 5	Byte 6	Byte 7
0xA1BA2f1	8	Analog#1(mV)	Analog#2 (mV)	CALPOT 1	CAL POT 2	Switch mask	Heartbeat		

Parameter	Description
Analog#1	Voltage value from analog #1 input 0-5000mV, big endian
Analog#2	Voltage value from analog #2 input 0-5000mV, big endian
Switch mask	bit mask of pressed switches (1 means pressed)
CAL POT #1	The discrete value of analog #1 input. The voltage for each value is multiplication of 384mV
CAL POT #2	The discrete value of analog #2 input. The voltage for each value is multiplication of 384mV
Heartbeat	Counter incremented every sent message

LED CONTROL

For LED control the appropriate message should be sent to CSB. The incoming message Id is as follow:

Base ID	LED control ID
0x334	0x434
0x666	0x766
0xA1BA2f1	0xa1ba2f2

The message format is:

ID	DLC	Byte 0	Byte 1	Byte 2	Byte 3	Byte 4	Byte 5	Byte 6	Byte 7
	8	Led1 ctrl	Led2 ctrl	Led1 state	Led2 state	0	0	0	0

To control particular LED output Led control flag must be set to 1 and then led state is set. For example:

To turn on Led#1: 0x766, 8, 1,1,1,1 must be send
 To turn off Led#2: 0x766, 8, 0,1,0,1 must be send
 To turn on Led#1 and Led#2 : 0x766, 8, 1,1,1,1 must be send

LED outputs switch to the ground.